

D2500Py

Professional Compression Driver



KEY FEATURES

- 2.5" Voice coil and 2" exit
- 100 Watts continuous power handling
- 109 dB Sensitivity
- Polyimide Diaphragm
- 800 - 17,000Hz

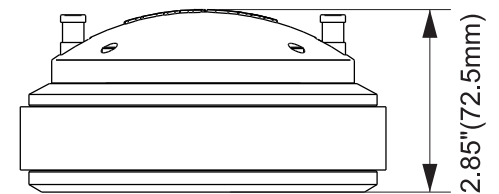
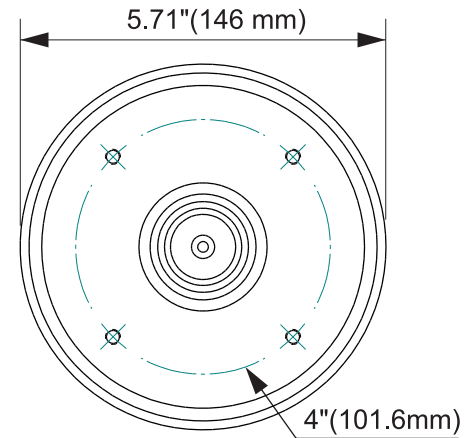

GENERAL SPECIFICATIONS

Exit Throat Diameter	2" (50 mm)
Nominal Impedance	8 Ohms
Rated Power Handling	100 Watts
Program Power	200Watts
Sensitivity 2.83V at 1m*	109 dB
Recommended High Pass Crossover**	900 Hz***
for Full Power Handling	*12 db/oct Crossover
Frequency Response at -10dB	800-17,000Hz
Voice Coil Diameter	2.5" (65 mm)
Voice Coil Wire	CCAW
Voice Coil Former Material	Kapton®
Diaphragm Material	PEI
Flux Density	21.1 T
Magnet Material	Ferrite

EXTRA INFO

Overall Diameter	5.71" (146 mm)
Overall Depth	2.85" (72.5 mm)
Mounting Bolt Circle	M6 x 4 - 4" (101.6 mm)
Net Weight	8.82 lbs (4.0 kg)
Shipping Weight	9.03 lbs (4.1 kg)
Carton Dimensions W x L x H	5.83" x 5.83" x 3.34" (148 x 148 x 85 mm)

Frequency Response Measured at 2.83v/1m

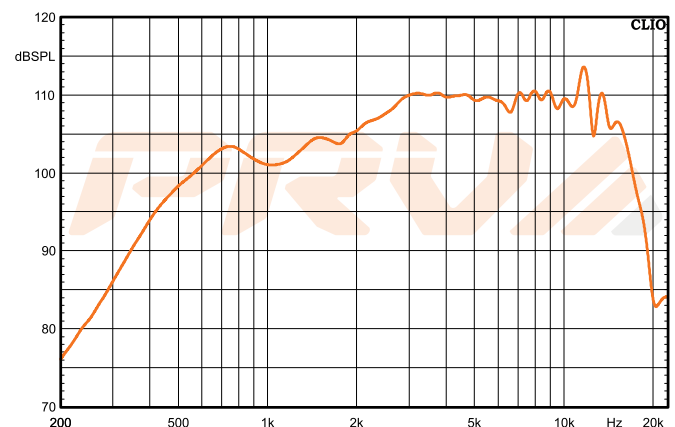

*Frequency Response Measured on WG14-50CR

PRV AUDIO USA (USA and Export) PRV AUDIO BRAZIL (Brazilian Sales Only)
 POMPANO BEACH, FL SAO LEOPOLDO, RS
 support@prvaudio.com vendas@pvaudio.com.br
 www.prvaudio.com www.pvaudio.com.br